

## DESCRIPTION

The HAFM Series of active multipliers is available in models ranging from 30 to 100 GHz. A wide variety of multiplication factors from X2 up to X6 provide the customer with design flexibility for many applications. Basic multiplier circuits can be cascaded to achieve higher order multiplication factors.

Active multipliers are often used in LO chains in radars and communication systems, allowing the use of low phase noise frequency sources at lower frequencies. Multipliers also find use in frequency extenders for test equipment.

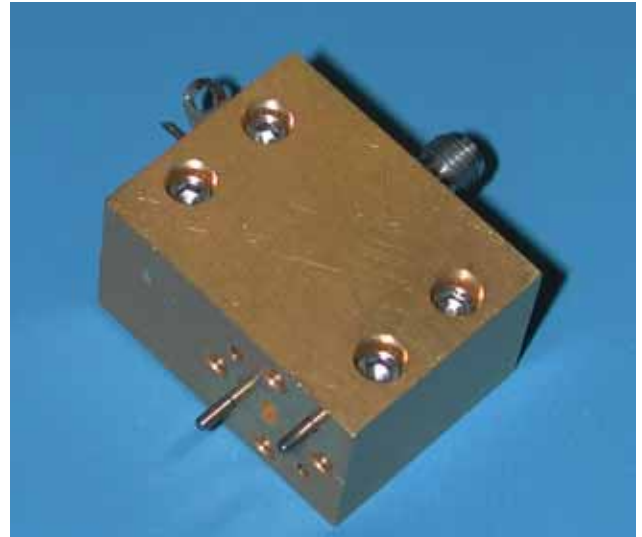

## Applications

- Local Oscillators Chains
- Radar Sources
- Communication Sources
- Test Equipment

## Features

- Low Cost MMIC construction
- Low Drive Levels
- High Output Power
- Small Size for integrated systems

## Active Frequency Multiplier Specifications - 18 to 68 GHz

This is just a sample listing of available active frequency multipliers. Please choose from these models or contact factory with your requirements. Please identify your required frequency range with any inquiry.

Model Number	Input / Output Frequency Range (GHz)	Mult Factor	Input Connector	P <sub>IN</sub> (dBm) 2,3	Typical Output Power 2,3	Output Connector
HAFMK2-185	9.0 - 13.25 / 18.0 - 26.5	X2	2.9 mm F	+3	+10	WR-42 / UG-595/U
HAFMK2-X	9.0 - 13.25 / 18.0 - 26.5	X2	2.9 mm F	+10	+27	WR-42 / UG-595/U
HAFMA2-116	12.0 - 16.5 / 24.0 - 33.0	X2	2.9 mm F	+10	+15	2.9 mm F
HAFMA2-052	14.0 - 18.0 / 28.0 - 36.0	X2	SMA F	+13	+18	WR-28 / UG-599/U
HAFMA2-117	16.0 - 20.0 / 32.0 - 40.0	X2	2.9 mm F	+13	+13	2.9 mm F
HAFMA2K-324	16.0 - 20.0 / 32.0 - 40.0	X2	2.9 mm F	+10	+17	2.9 mm F
HAFMA4-212	8.5 - 9.0 / 34.0 - 36.0	X4	SMA F	+4	+12	WR-28 / UG-599/U
HAFMB4K-328	9.0 - 11.0 / 36.0 - 44.0	X4	2.4 mm F	-5	+16	2.4 mm F
HAFMQ4-339	10.0 - 12.0 / 40.0 - 48.0 (50)	X4	2.9 mm F	+7	+10	WR-22 / UG-599/U*
HAFMU2-118	23.5 - 25.0 / 47.0 - 50.0	X2	WR-28	+13	+13	WR-19 / UG-599/U-M*
HAFMV4-208	12.5 - 12.75 / 50.0 - 51.0	X4	2.9 mm F	+10	+15	WR-15 / UG-385/U
HAFMV2-A	25.0 - 28.0 / 50.0 - 56.0	X2	2.9 mm F	+13	+13	WR-15 / UG-385/U
HAFMV4-157	25.5 - 27.5 / 51.0 - 55.0	X4	2.9 mm F	+10	+15	WR-15 / UG-385/U
HAFMV4-244	13.0 - 15.25 / 52.0 - 61.0	X4	2.9 mm F	+10	+13	WR-15 / UG-385/U
HAFMV2-188	26.0 - 32.5 / 52.0 - 65.0	X2	2.9 mm F	+13	+10	WR-15, UG-385/U
HAFMV4-187	13.0 - 17.0 / 52.0 - 68.0	X4	2.9 mm F	+5	+13	WR-15 / UG-385/U
HAFMV4-136	14.25 - 16.5 / 55.0 - 65.0	X4	2.9 mm F	+7	+13	WR-15 / UG-385/U
HAFMV4-321	14.25 - 16.5 / 57.0 - 66.0	X4	2.9 mm F	+7	+12	WR-15 / UG-385/U
HAFMV4-223	14.25 - 16.5 / 57.0 - 66.0	X4	2.9 mm F	+10	+14	WR-15 / UG-385/U
HAFMV4-294	14.375 - 15.125 / 57.5 - 60.5	X4	2.9 mm F	+10	+15	WR-15 / UG-385/U
HAFMV4-204	14.5 - 15.5 / 58.0 - 62.0	X4	2.9 mm F	+12	+14	WR-15 / UG-385/U

*See next page for multipliers above 70 GHz.*

Specifications @ 35°C T<sub>CASE</sub>. Specifications subject to change w/o notice.

\*Flange adapters are available to convert to UG-383/U (round) flange.



# Series HAFM Active Frequency Multipliers

Revised April 2013

## Active Frequency Multiplier Specifications - 68 to 100 GHz

This is just a sample listing of available active frequency multipliers. Please choose from these models or contact factory with your requirements. Please identify your required frequency range with any inquiry.

Model Number	Input / Output Frequency Range (GHz)	Mult Factor	Input Connector	P <sub>IN</sub> (dBm) 2,3	Typical Output Power 2,3	Output Connector
HAFME2-120	33.5 - 35.0 / 67.0 - 70.0	X2	WR-28	+15	+13	WR-12 / UG-387/U
HAFME4-255	17.5 - 18.75 / 70.0 - 75.0	X4	2.9 mm F	+13	+13	WR-12 / UG-387/U
HAFME6-163	11.83 - 12.17 / 71.0 - 73.0	X6	SMA F	+10	+15	WR-12 / UG-387/U
HAFME4-139	17.75 - 19.0 / 71.0 - 76.0	X4	2.9 mm F	+10	+13	WR-12 / UG-387/U
HAFMW4-209	17.75 - 19.0 / 71.0 - 76.0	X4	2.9 mm F	+13	+13	WR-10 / UG-387/U-M
HAFME4-213	18.0 - 19.5 / 72.0 - 78.0	X4	2.9 mm F	+13	+13	WR-12 / UG-387/U
HAFME4-325	18.0 - 20.0 / 72.0 - 80.0	X4	2.9 mm F	+10	+12	WR-12 / UG-387/U
HAFMW4-170	19.25 - 20.25 / 77.0 - 81.0	X4	2.9 mm F	+7	+10	WR-10 / UG-387/U-M
HAFMW6-195	13.5 - 14.33 / 81.0 - 86.0	X6	SMA F	+13	+13	WR-10 / UG-387/U-M
HAFMW3-122	29.0 - 30.0 / 87.0 - 90.0	X3	WR-28	+15	+13	WR-10 / UG-387/U-M
HAFMW6-232	15.33 - 16.17 / 92.0 - 97.0	X6	SMA F	+10	+13	WR-10 / UG-387/U-M

Specifications @ 35°C T<sub>CASE</sub>. Specifications subject to change w/o notice.

## Active Multiplier Outlines

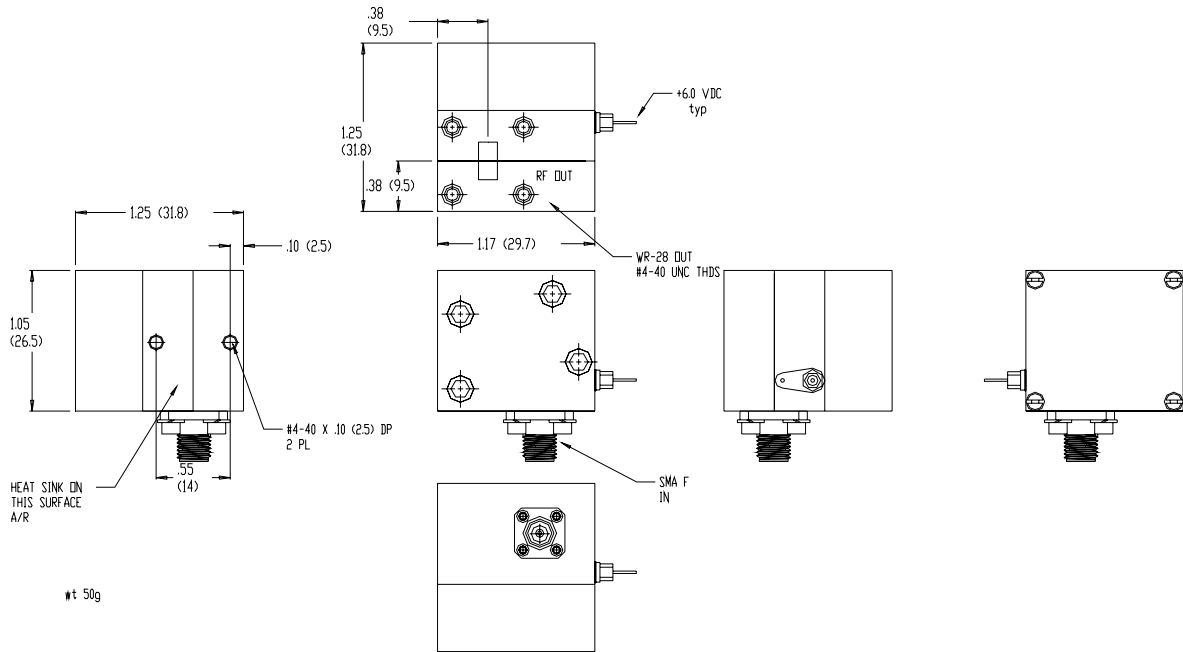

## Ka-Band Active Doubler

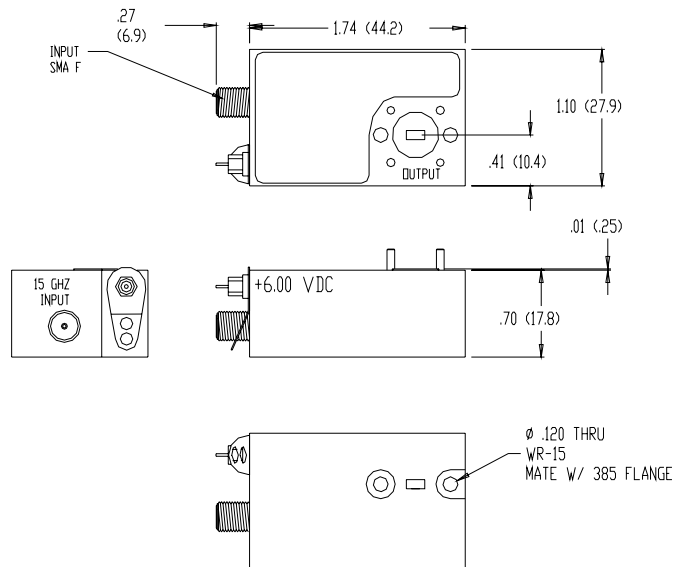

## V-Band X4 Active Multiplier

## Active Multiplier Outlines

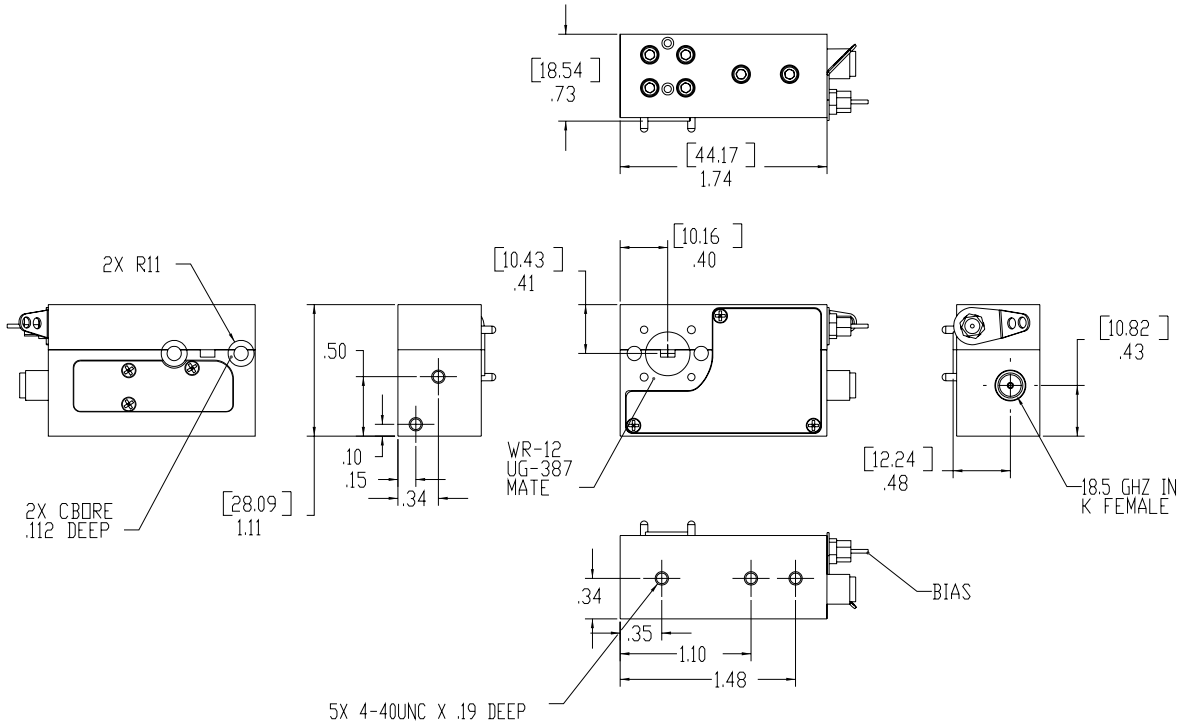

## E-Band X4 Active Multiplier

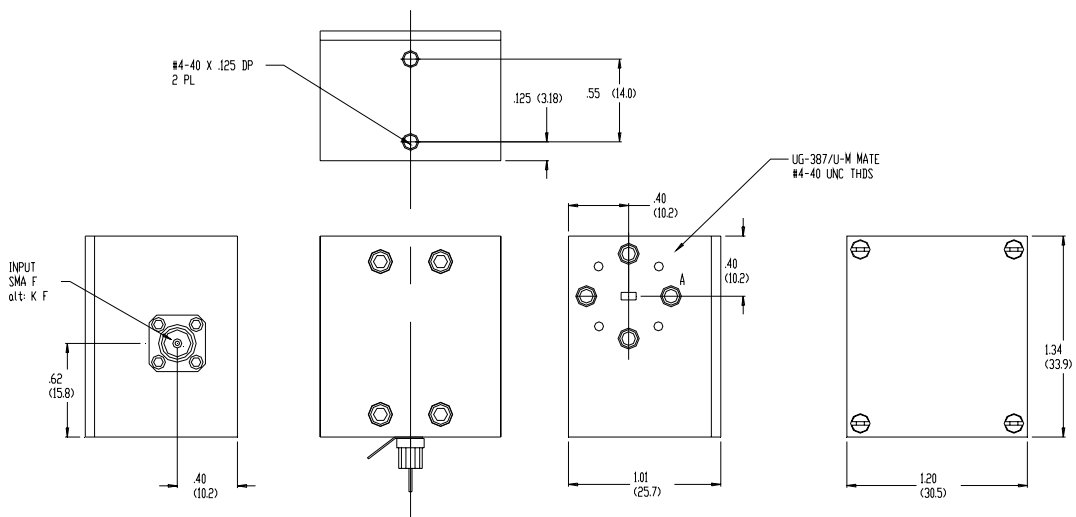

## W-Band X4 Active Multiplier

## Active Multiplier Outlines

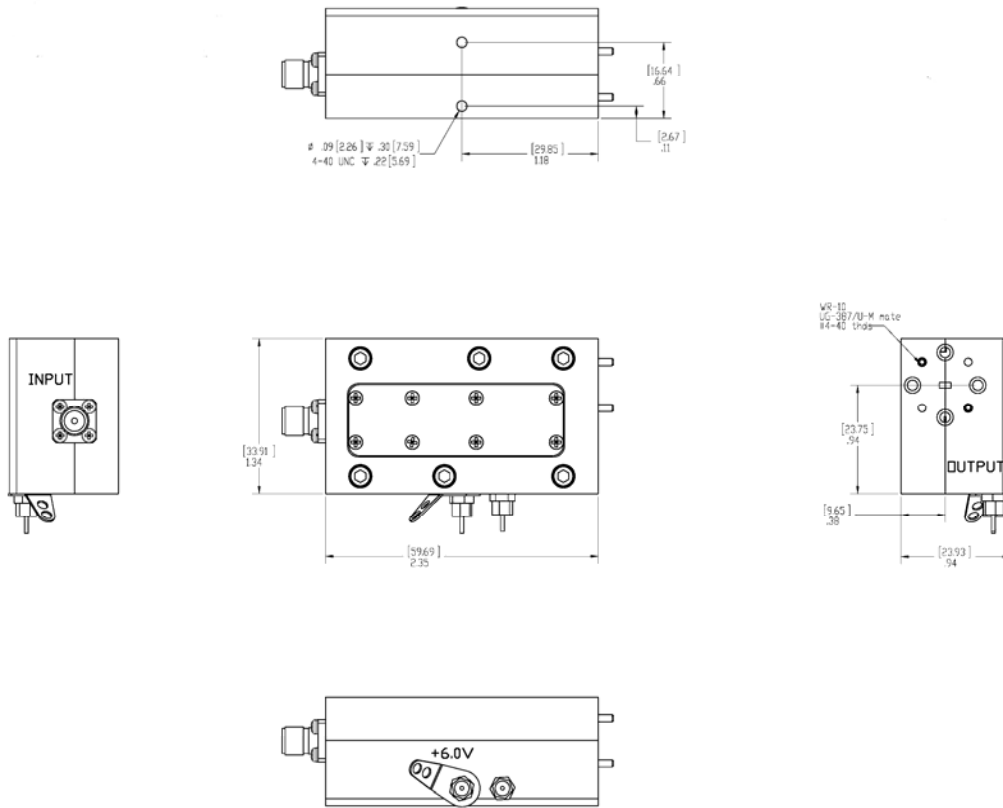

**W-Band X6 Active Multiplier**



# Series HAFM Active Frequency Multipliers

Revised April 2013

## Requesting Quotes

When requesting a quote for HAFM active multipliers, please specify desired frequency range and input/output power levels, as well as any other required specifications. HAFM multipliers are built to order and will be optimized for the bandwidth specified by the customer. The part numbering system below can also be used as a reference.

Example: W-Band frequency tripler

HAFM W 3 - XXX

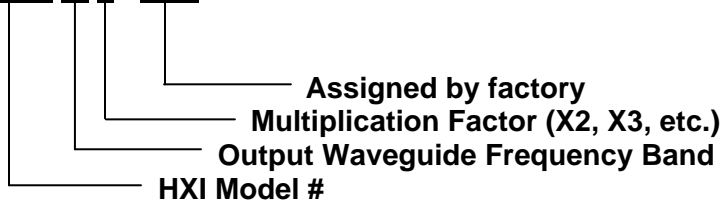

## Options

SMA Female input connector available to 20 GHz.  
2.9 mm inputs available to 40 GHz.